

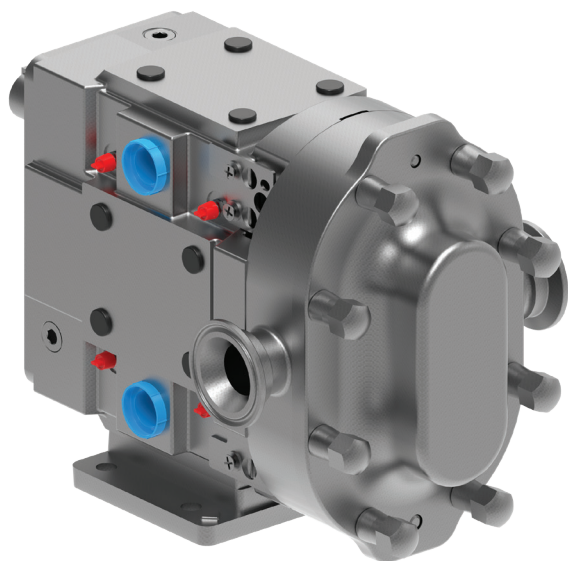

TRA®10 SERIES™

CIRCUMFERENTIAL PISTON PRODUCT LINE



FEATURES & BENEFITS

CLEANABILITY

- Easy disassembly for easy COP (Clean Out of Place)
- Designed to 3A standards

PERFORMANCE

- Efficient handling for low & high viscosity applications
- Exclusive, non-galling WFT 808® alloy rotors standard; permits running at tighter clearances
- High strength 17-4 PH single piece shaft standard on 0300 and larger
- Helical gears, improving load carrying capabilities

EASE OF MAINTENANCE

- Drop-in-place with TRA®20 & comparable manufacturer models
- Interchangeable service parts with comparable manufacturer models
- Easy disassembly

PERFORMANCE

MODELS

Model	Displacement		Max Pressure		Max Speed	Standard Ports		Max Capacity	
	USG/rev.	l/rev.	PSI	BAR	RPM	In	mm	GPM	m³/h
0060	0.008	0.03	200	14	800	1.5	38	6	1.3
0150	0.014	0.052	200	14	700	1.5	38	9	2
0180	0.03	0.11	200	14	600	1.5	38	17	3.8
0300	0.06	0.23	200	14	600	1.5	38	36	8.2
0450	0.1	0.38	400	27	600	2	51	59	13.3
0600	0.15	0.58	200	14	600	2.5	64	90	20.4
1300	0.25	0.96	200	14	600	3	76	150	34.1
2200	0.52	1.98	200	14	600	4	102	310	70.4
3200	0.75	2.85	200	14	600	6	152	450	102

RECTANGULAR FLANGE MODELS

Model	Displacement		Max Pressure		Max Speed	Inlet (WxL)		Outlet		Max Capacity	
	USG/rev.	l/rev.	PSI	BAR	RPM	In	mm	In	mm	GPM	m³/h
0340	0.06	0.22	200	14	400	1.75 x 6.75	44.50 x 171.45	2	50.8	24	5.4
0640	0.15	0.57	200	14	400	2.24 x 8.82	56.90 x 224.03	2.5	57.2	60	13.6
1340	0.25	0.96	200	14	400	2.97 x 9.25	75.44 x 234.95	3	76.2	100	22.7
2240	0.52	1.97	200	14	400	3.87 x 11.00	98.30 x 279.40	4	101.6	200	45.4



CAPACITY
to 450 GPM
(102 m³/h)



PRESSURE
to 400 PSI
(27 BAR)



VISCOSITY
to 910,000 SSU
(200,000 cSt)



TEMPERATURE
to +300°F
(+150°C)

PORTING

- Complete range of hygienic clamp, screw, flange & industrial screw connections
- Tri-clamp, flanged, DIN, IMDA, NPT, BSP, etc.

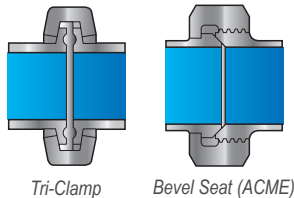

SEALING

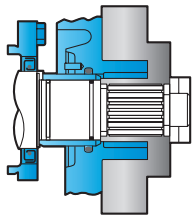

- Single O-ring
 - Standard O-rings & Cover Seals: *Buna/FDA*
 - Optional O-rings & Cover Seals: *FKM, EPDM, Silicone*

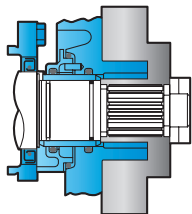

- Double O-ring with Flush
 - Standard O-rings & Cover Seals: *Buna/FDA*
 - Optional O-rings & Cover Seals: *FKM, EPDM, Silicone*

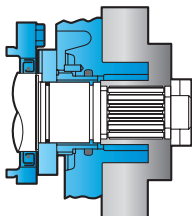

- Single Mechanical
 - Standard Seal Faces: *SiC/SiC*
 - Standard O-rings & Cover Seals: *Buna/FDA*
 - Optional Faces: *Carbon, Ceramic or Chrome Oxide*
 - Optional O-rings & Cover Seals: *FKM, EPDM, Silicone*

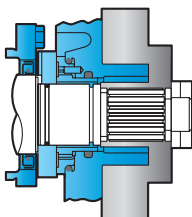

- Double Mechanical with Flush
 - Standard Seal Faces: *SiC/SiC/C*
 - Standard O-rings & Cover Seals: *Buna/FDA*
 - Optional Faces: *Carbon, Ceramic or Chrome Oxide*
 - Optional O-rings & Cover Seals: *FKM, EPDM, Silicone*

GEAR BOX

- 304 stainless steel standard on 0060 - 2240 models
- Powder coated cast iron standard on 3200 model

ROTOR & CASING OPTIONS

- 316 stainless steel pump casing standard w/ interior finished to 3-A standards
- Non-galling WFT 808® nickel alloy rotors standard or 316 stainless steel rotors optional
- Optional clearances: front face, hot, high temperature/high viscosity (chocolate)
- Twin Wing Rotors Standard
 - Suitable for all liquids, provides minimum pulsation
- Single Wing Rotors Optional
 - Standard Provides reduced shear on shear sensitive fluids or large solids such as fruit pieces, nut kernels, cheese curds or meats

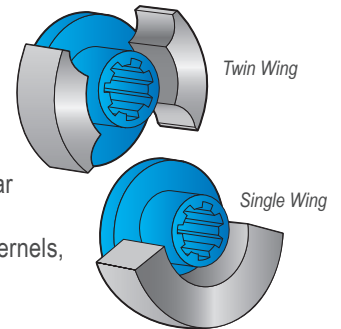

MOUNTING

- A gear case that can be mounted in any of four positions allows for horizontal or vertical porting, flexibility in drive shaft positioning to match reducer or gear motor input & improved access to grease fittings

TYPICAL APPLICATIONS

- Dairy
- Bakery
- Meat Processing
- Foods
- Confectionary
- Paints
- Chemical

WHY REMANUFACTURE?

- Worn pump is returned to **like-new condition & performance**
- Your remanufactured pump carries a **full 1 year factory warranty**
- All remanufactured pumps are **tested & certified**
- Save big** compared to purchasing an entirely new pump
- Pumps can be remanufactured **up to four times**, depending on model & wear

VIKING PUMP CANADA

Viking Pump of Canada, Inc.
A Unit of IDEX Corporation
661 Grove Ave
Windsor, Ontario N9A 6M3 Canada
vikingpumpcanada.com

CONTACT YOUR STOCKING DISTRIBUTOR TODAY

YOHANCE HENRY
Market Manager
(519) 259-4268
yhenry@idexcorp.com

CUSTOMER SERVICE
1 (888) 845-7867
wccs@idexcorp.com